

P Item	CODICE Code	DESCRIZIONE Designation
1	ZA91103R	Cartuccia Ø35mm con distributore
2	ZGHI010	Ghiera ferma cartuccia 37 x 1
3	ZCAP034..	Cappuccio sottoleva metallo 37x1
4	ZLEV133..	Leva SLY
5	ZAER002..	Aeratore completo Ø24
6	ZBAS077..	Basetta
7	ZFLX001..	Set flex inox 3/8" cm.35 c/guar.
8	ZFIS004	Set di fissaggio
9	ZAST046..	Asta pomolo snodino Ø4mm piegata
10	ZSCA002..	Scarico 1'1/4 modello NEW (ZM) c/tappo host.

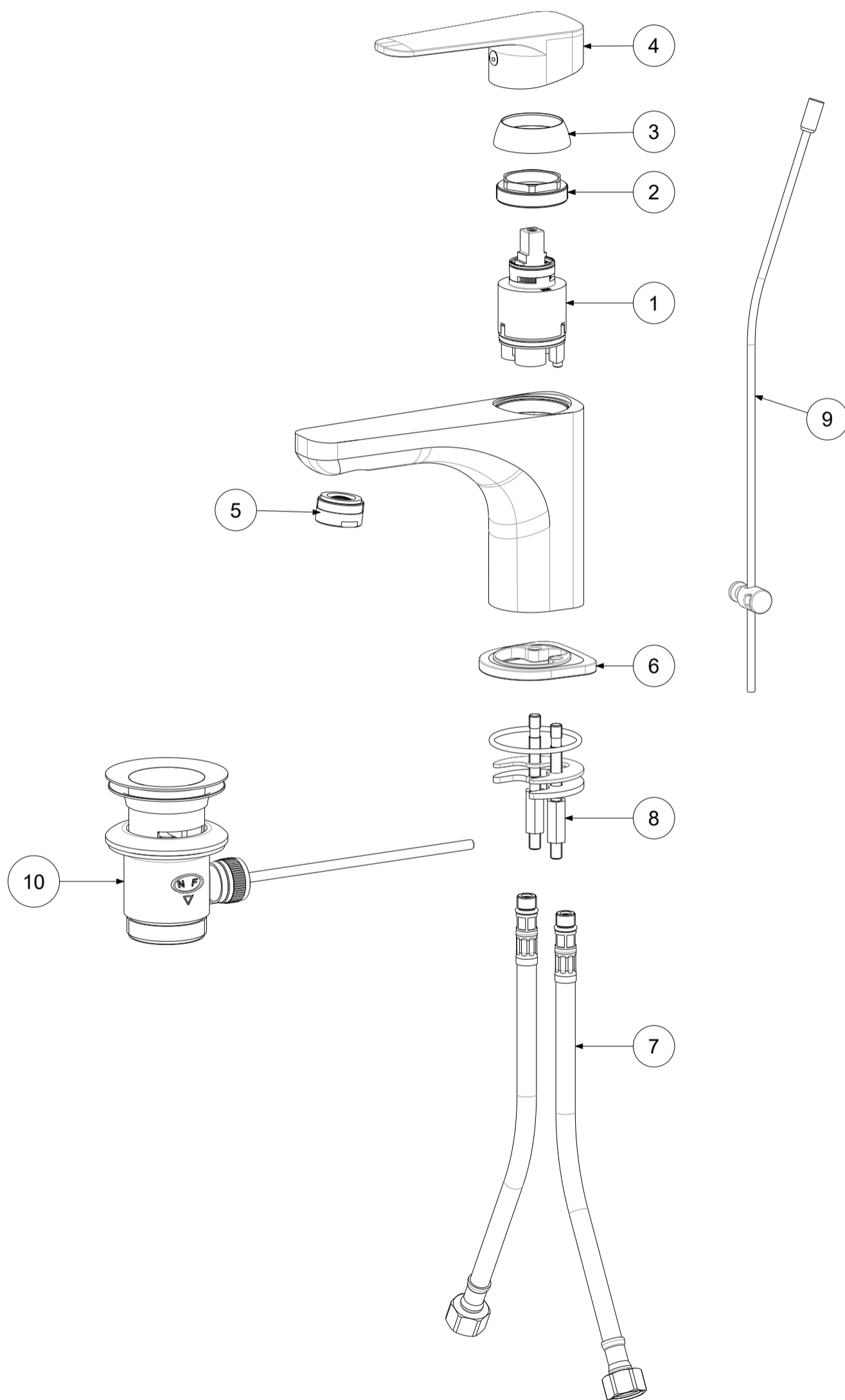

	APPROVATO: Approved:			A3	SCALA Scale	0,400	MATERIALE Material	VARI
	DISEGNATO: Design:	Giampani	26/11/2020		UNITA' Unit	mm	SERIE Range	SLY
			DESCRIZIONE - Description: Miscelatore lavabo S/A 1"1/4 Wash basin mixer 1" 1/4 PUW					
FOGLIO - Sheet:		Ricambi		CODICE - Part Number:		SY075CR		