

ZSOF

029 ARIZONA	010
030 ISCHIA	015
031 ALABAMA	016
032 OREGON	017
046 BELINDA	018
075 SYNCRO	034
077 BERRY	035
074 MASTER	038
078 SYNCRO KING	061
079 MASTER KING	062
080 BERRY KING	063
081 NIRVANA	063..350
082 TURBO	064
091 CITY	065
092 WIND	073
093 BAHAMAS	090
094 JAMAICA	118
095 HAWAI	119
096 ZANZIBAR	306 Inox tech
101 MASTER SPECIALE	307 Inox tech
102 BLANC	308 Inox tech
103 ENERGY	309 Inox tech
104 ORIGINAL	
115 PANDA	

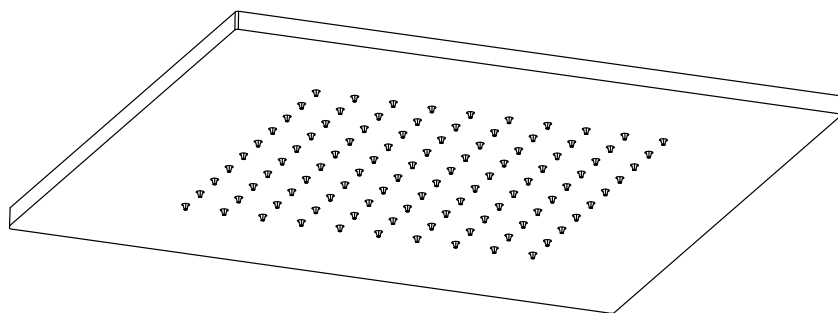

1

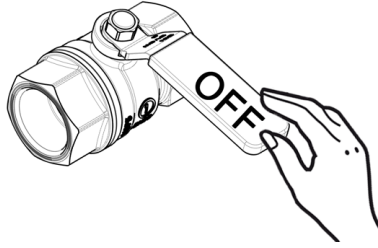

$65 \pm 5^\circ\text{C}$



$15 \pm 5^\circ\text{C}$

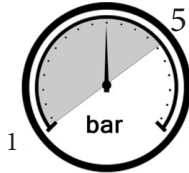

MIN - MAX



OK

Δp MAX 1bar

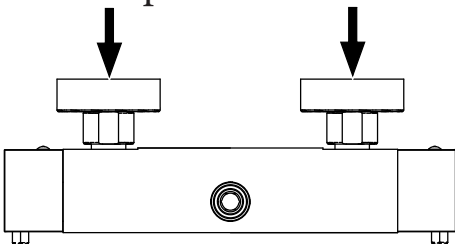

Δp : differenza pressione in entrata
different inlet water pressure

2

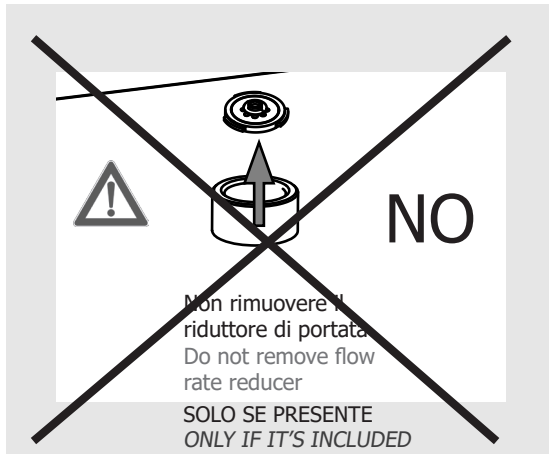

3

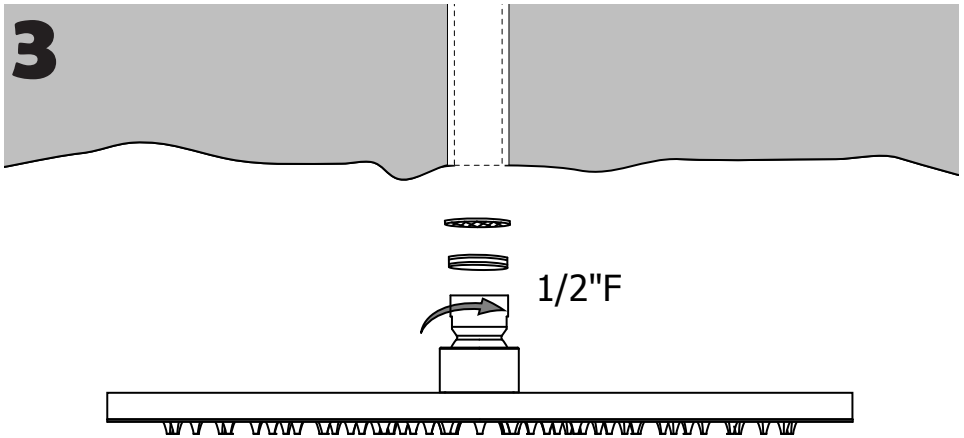

4

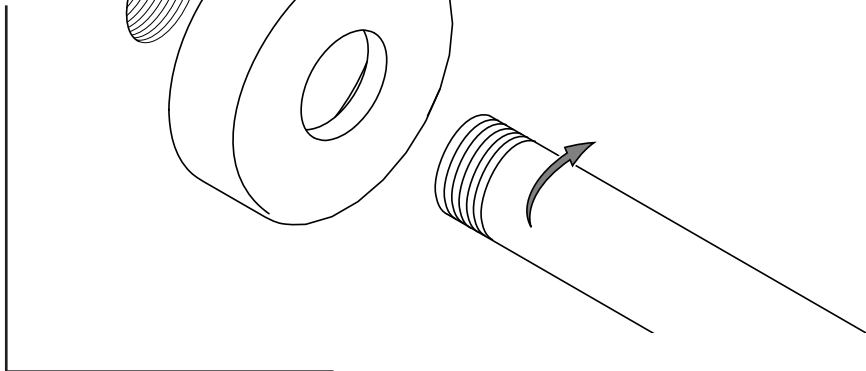

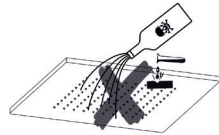
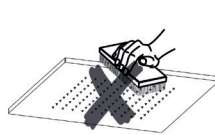
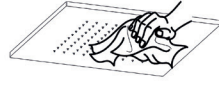
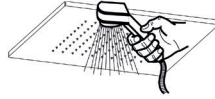
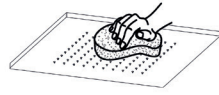
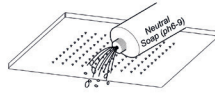

P Pulizia
Cleaning

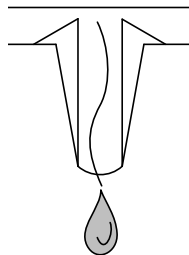
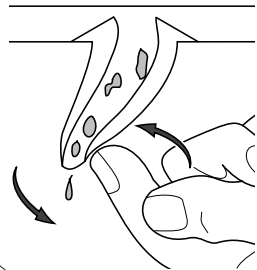
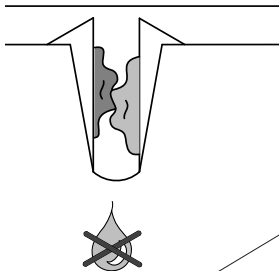
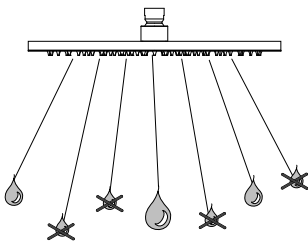



ITALIANO

L'installazione deve essere eseguita in conformità alle norme edilizie e di sicurezza vigenti e a quelle relative agli impianti idraulici.

ENGLISH

The installation must be carried out in compliance with current building and safety regulations, as well as with the applicable plumbing standards. All required safety precautions must be observed.



ITALIANO

Controllare il prodotto installato ad intervalli regolari per assicurarsi che non ci siano perdite o parti instabili.

ENGLISH

Periodically inspect the installed product to ensure there are no leaks or unstable parts, and take immediate action if any irregularities are detected.



ITALIANO

Tenere fuori dalla portata dei bambini.

ENGLISH

Keep out of reach of children.

